

2W DUAL OUTPUT DC-DC CONVERTER

INSTRUCTIONS:

- Good temperature characteristic
- Isolation voltage 1500VDC
- Small SIP/DIP package
- International standard pins
- Internal placement design structure
- Comply with RoHS directive
- When in use, the load must not be less than 10%

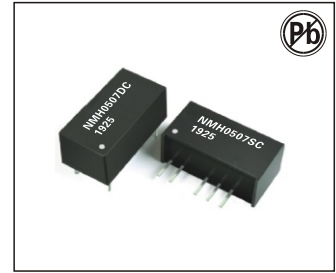

ELECTRICAL CHARACTERISTICS@25°C

Part No./Customer P/N	NMH0507DC/AM2D-0507DZ
Input range	4.5~5.5
Output(Voltage,current)	± 7.2VDC/ ± 139mA
Output current	± 14mA
Efficiency	78TYP
Load capacitance	470uF
Output voltage accuracy (input voltage range, 100% load)	-7.5 (MIN) ,+2.5(MAX)
Load regulation	15(TYP) 20(MAX)
Voltage regulation	1(TYP) ± 1.2 (MAX)
Output ripple + noise (20MHz bandwidth, nominal voltage input 100% load)	50 mV(TYP) 80 mV(MAX)
Switching frequency	100KHz(TYP)
Output short circuit protection	1S (Max)
Temperature drift coefficient (nominal voltage input 100% load, -40°C ~ +85°C)	± 0.03%/°C(MAX)
Store humidit	95%(MAX)
Working temperature (temperature ≥ 85°C for derating use)	-40°C ~ 85°C
Storage temperature	-55°C ~ 125°C
The shell heats up when the product is working	35°C (TYP)
Insulation strength (test time 1 min, leakage current less than 0.5mA)	1500VDC
Cooling way	Natural cooling
Mean trouble-free time (TA=25°C)	1 million hours
Insulation resistance (insulation voltage 1000VDC)	1000MΩ (MIN)
The shell material	Flame-retardant heat-resistant plastics(UL94-V0)

TEMPERATURE DROP CURVE OF OUTPUT POWER

TEMPERATURE DERATING GRAPHS

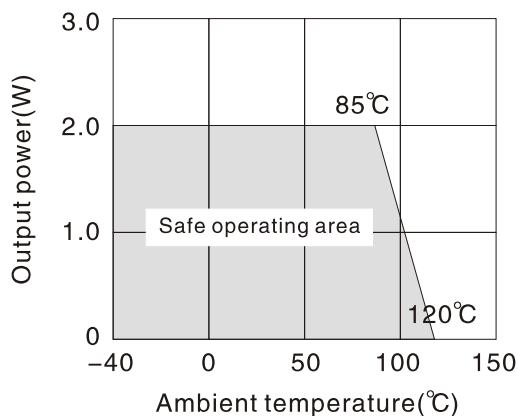

TOLERANCE ENVELOPES

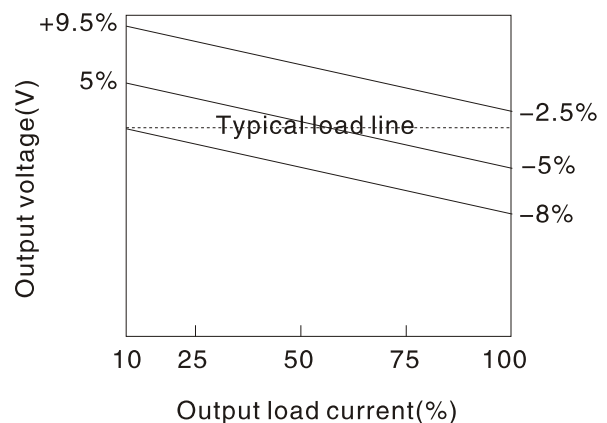

2W DUAL OUTPUT DC-DC CONVERTER

PRECAUTIONS FOR USE

1.OUTPUT LOAD REQUIREMENT:

In order to ensure that the module can work efficiently and reliably, the minimum output load of the module can not be less than 10% of the rated load when in use, and the product is strictly prohibited to use without load!!If your power requirement is really small, please parallel a resistor at the output end. It is recommended that the resistance value is equivalent to 10% of the rated power, or choose our product with lower power level.

2.RECOMMENDED CIRCUIT:

If further reduction of input-ripple is required, a capacitive filtering network can be connected to the input-output terminal, as shown in the application circuit (figure 1)

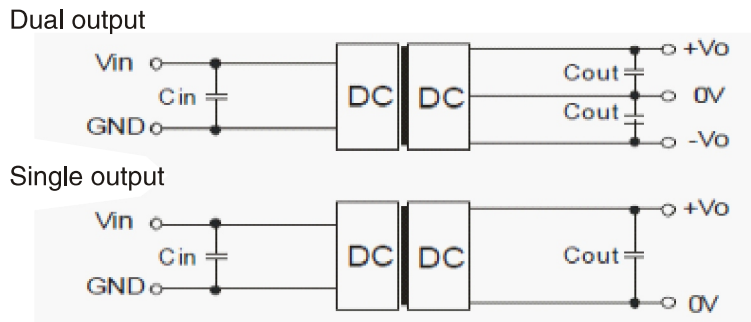

Figure 1

Vin (VDC)	Cin (uF)	Single output voltage (VDC)	Cout (uF)	Lout (uH)	Dual output voltage (VDC)	Cout (uF)	Lout (uH)
3.3/5	4.7	3.3	10	22	± 5	4.7	47
12	2.2	5	10	22	± 9	2.2	47
15	2.2	9	4.7	47	± 12	1	150
24	1	12	2.2	47	± 15	0.47	100
48	1	15/24	1	68	± 24	0.47	100

Please choose a low ESR capacitor. For applications where the actual output power is less than 0.5W, external capacitance is not recommended

Capacity load table (table 1)

However, appropriate filter capacitance should be selected.If the capacitance is too large, it may cause startup problems.For the selection of output capacitance, please refer to the capacitive load table

3.THIS PRODUCT CAN NOT BE USED IN PARALLEL AND DOES NOT SUPPORT HOT PLUG

PRODUCT RIPPLE & NOISE TESTING

The ripple noise test of the product is carried out according to the following circuit.The sum of the voltage drops of the two parallel copper foil strips shall be less than 2% of the output voltage value

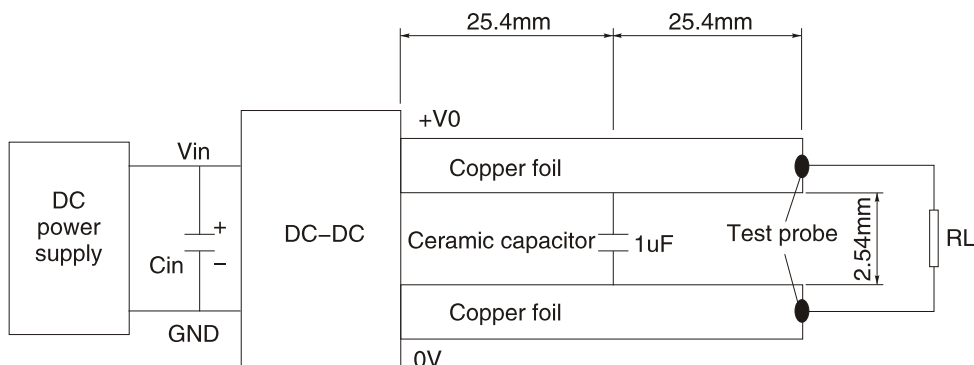

2W DUAL OUTPUT DC-DC CONVERTER

APPEARANCE DIMENSION, SUGGESTED PRINTING BOARD DRAWING, PIN WAY

DIP PACKAGE

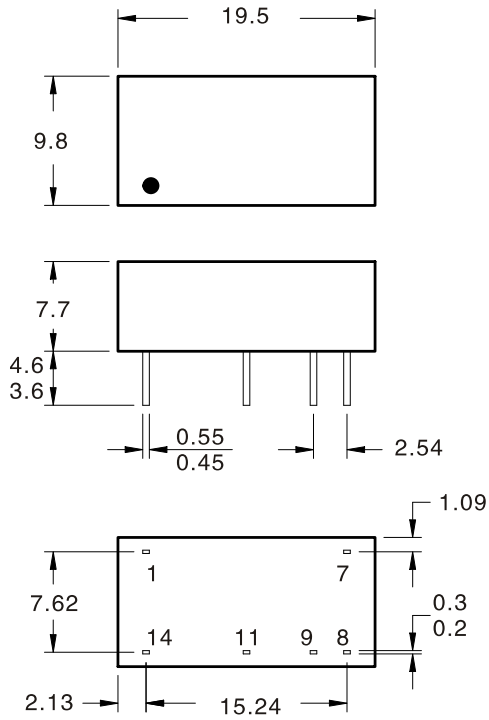

SIP PACKAGE

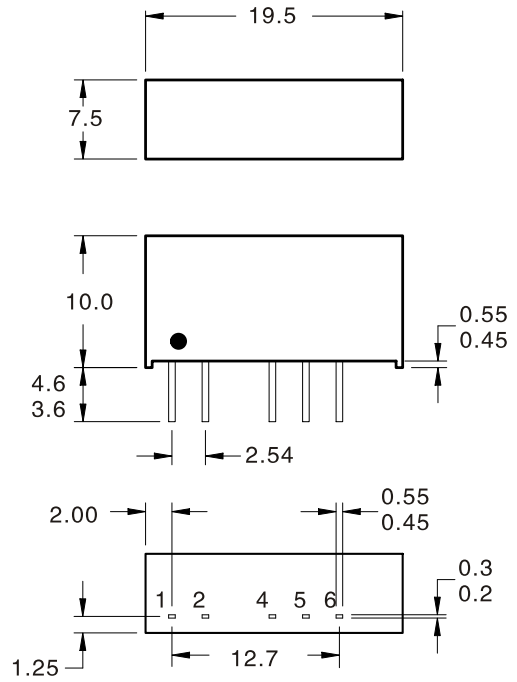

All dimensions in mm ± 0.25 mm. All pins on a 2.54mm pitch and within ± 0.25 mm of true position
 Weight: 2.85g(DIP) 2.76g(SIP)

PIN WAY

PINS	DIP
14	Vin
1	GND
8	0V
9	+V0
11	-V0
7	NC

PINS	SIP
1	Vin
2	GND
4	-V0
5	0V
6	+V0

RECOMMENDED PAD

SIP

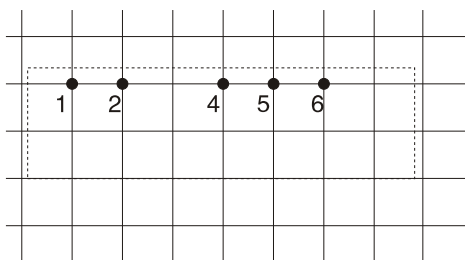

DIP

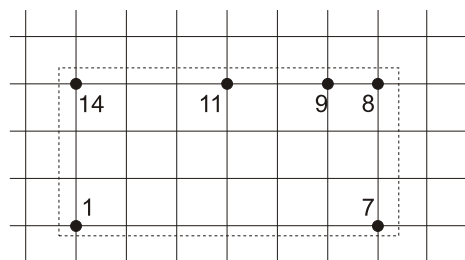

2.54mm*2.54mm/grid